

# Sliding Security Screen Door Hardware



**Whitco**<sup>®</sup>  
SECURING YOUR HOME™

**10YEAR** MECHANICAL WARRANTY

[whitco.com.au](http://whitco.com.au)

# Contents



Leichhardt

page 3



Cylinder – Euro Profile  
Lazy Camk

page 5



Bass

page 6



Sliding Screen  
Door Rollers

page 8

## Application/Description

Single & Multi point mortice sliding security door lock.

## Features and Specifications

- Suits either Left or Right hand closing sliding doors
- Parrot beak deadlock
- Key deadlock from both sides
- Self latching
- Inside snib
- Key overrides snib operation
- Accepts Whitco Euro profile lazy cam cylinder locks
- Can only be key locked or snibbed when fully latched with striker
- Optional Multi Point kits available for 2 and 3 point applications
- Zinc diecast furniture and locking mechanism
- Steel zinc plated cover plate



Aluminium

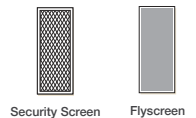

Available in Display and Trade Packs.

## Keying

- Use with Whitco Euro profile lazy cam cylinder locks
- 2 x 5 pin cylinder lock
- 2 x 10 disc cylinder lock

## Non Standard Finishes

Other polyester powder coat finishes available on application.

## Ordering

### Display Pack

Standard striker, furniture no cylinder centre lock, screws **W8679••**

### Trade Pack - Standard

Centre lock furniture, Standard parrot beak bolt and strike, inside snib, no cylinder – Single point lock Mechanism, suits standard 20 mm doors **W866717**

Furniture with extended lever and snib – Single point lock mechanism, suits 30 mm door thickness **W8669••**

Furniture, standard Parrot beak bolt & strike, inside snib, no cylinder – to suit multi point kits **W8653••**

Furniture, snib inside only - mechanism, Standard strike, No cylinder (right hand) **W866417**

(left hand) **W866517**

Dummy Pull set – Internal and external pull **W866617**

•• Denots finish. See price list for available pack / finish combinations

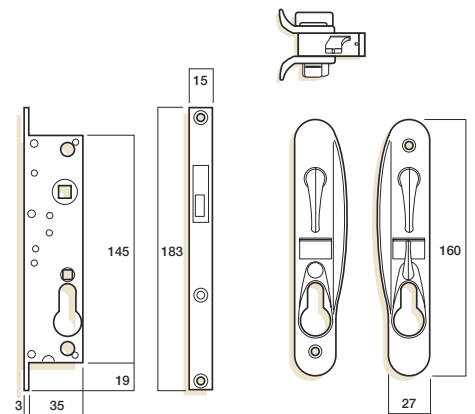

Cylinder locking

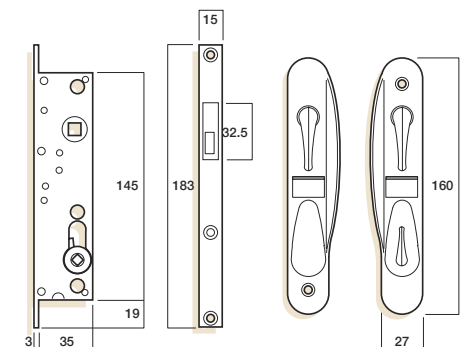

Snib locking



Accessories	
<b>Standard centre lock keeper</b>	
Zinc diecast, Zinc plated	W868101
<b>Wideline Keeper</b>	
Suits Wideline section / Zinc diecast, Zinc plated	W866801
<b>Multi point kit - 3 point</b>	
3 point lock kit including rods, two auxiliary locks, keeper & screws, suits door height up to 2040 mm	
Above centre line kit	W867117
Below centre line kit	W867217
<b>Multi point kit - 2 point</b>	
2 point lock kit including rod, auxiliary lock, Keeper and screws, 1 mm	
W867317	
Suitable for doors accessing pool area. Where centre lock is at least 1,500 mm above Floor	

Standard Finishes	
Silver	11
Brown	13
White	16
Black	17
Gold Spangle	18
Primrose	19
Doeskin	23
Magnolia	24
Stone Beige	28

Furniture available in the following polyester powder coat finishes.

•• Denots finish. See price list for available pack / finish combinations

# Cylinder – Euro Profile Lazy Cam

## Application / Description

Cylinder to suit Whitco Leichhardt, Tasman and Tasman Escape security screen door locks.

## Features and Specifications

- Available in Bright Chrome
- Double cylinder, C4 key profile
- Brass and zinc diecast construction
- Made to Whitco specifications

Available in Display and Trade Packs.

## Keying

- Two versions available:
- 2 x 5 pin, C4 key profile cylinder lock, can be keyed alike to other Whitco
- 5 pin C4 cylinder locks
- 2 x 10 disc, profile cylinder locks
- Two Whitco chrome plated brass keys included

### Standard Finish

Bright Chrome

### Non Standard Finishes

Not available in other finishes.

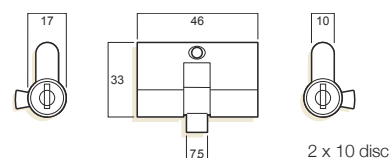
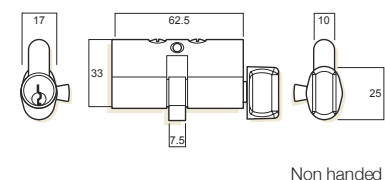
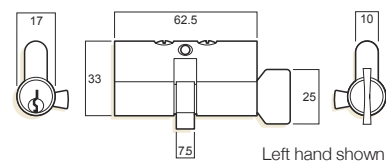
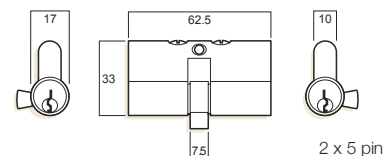

## Ordering

Display Pack Double Cylinder		Turnknob & 5 Pin	
2 x 5 Pin with screw	W840700	Random Keyed Turnknob & 5 Pin / Right Hand	W845500
2 x 10 Disc with screw	W840800	Random Keyed Turnknob & 5 Pin / Left Hand	W845600
Trade Pack 2 x 5 Pin / Double Cylinder		2 Keyed Alike / Turnknob & 5 Pin / Right Hand	W845700
Random Keyed	W841200	2 Keyed Alike / Turnknob & 5 Pin / Left Hand	W845800
2 Keyed Alike	W842200	Random Keyed / Non-handed Turnknob & 5 Pin	W841500
3 Keyed Alike	W842300	2 Keyed Alike / Non-handed Turnknob & 5 Pin	W841600
4 Keyed Alike	W842400	2 x 10 Disc / Double Cylinder	
10 Keyed Alike	W842500	Single Random Keyed	W841400
10 Keyed Alike - Gold Plated	W842502	2 Keyed Alike	W843200
20 Keyed Alike	W842600	3 Keyed Alike	W843300
50 Keyed Alike	W842800	4 Keyed Alike	W843400
Use In		10 Keyed Alike	W843500
Whitco Leichhardt Sliding Security Screen Door Lock		20 Keyed Alike	W843600
Whitco Tasman Hinged Security Screen Door Lock			
Whitco Tasman Escape Hinged Security Screen Door Lock			

## Application/Description

Sliding screen door latch.

## Features and Specifications

- Suits either Left or Right hand closing sliding doors
- Parrot beak latch
- Surface mounted
- Can be latched from inside or outside
- Slim low stand-off design
- Zinc die cast handle
- Galvanised steel lock plate and strike
- Available without lugs

Available in Trade Pack Only.

### Standard Finish

Black 17

### Non Standard Finishes

Not available in other finishes.



Aluminium  Timber



Flyscreen

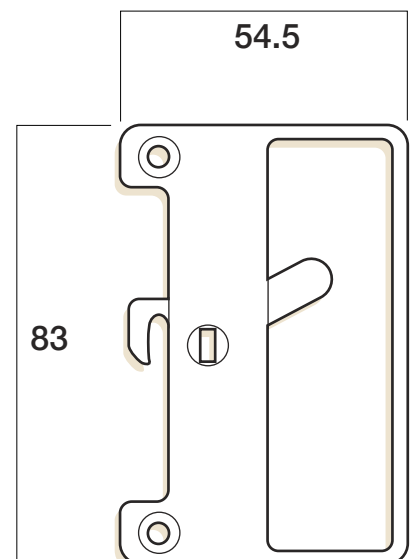

### Ordering

#### Trade Pack

Standard strike, standard body, finger plate and outer pull	W821317
Standard strike, standard body and outer pull	W821417
Standard strike, no lugs body and no outer pull	W821717

# Bass

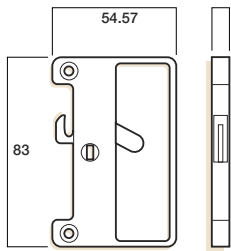

Standard Body **W821517**

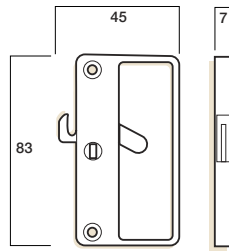

No lug body **W821717**

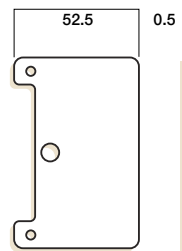

Finger Plate **W822317**

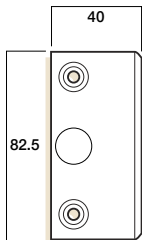

Outer pull with hole

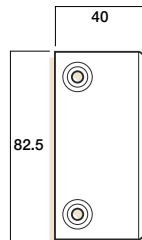

No hole outer pull **W822717**

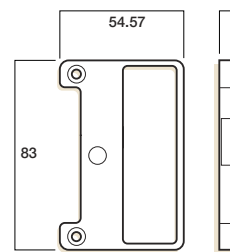

Dummy body **W824017**  
(Sold in packs of 600)

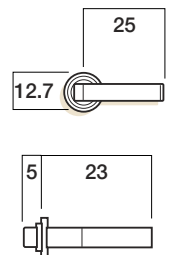

Snib

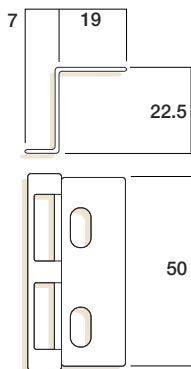

Standard strike

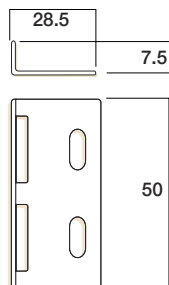

Bi-part strike **W822417**

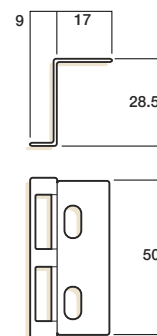

Stegbar strike **W822617**

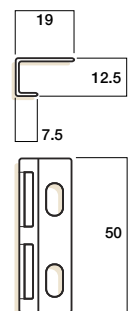

Jason strike **W822517**

# Sliding Screen Door Rollers

## Application/Description

Sliding Screen and Sliding Security screen door.

## Features and Specifications

- 'Speed Fit' applicator lugs
- Offset wheel function\*
- Fully adjustable under load
- Spring Loaded
- Large 11mm adjustment
- Adjustable from both sides
- Quick insert rim
- Inner case will not dislodge
- A + B identification for offset applications
- Retrofits existing rollers
- Suits both top and bottom rails

Available in Trade Pack Only.



Aluminium

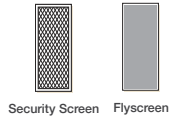

## Standard Finish

Black 17

## Non Standard Finishes

Not available in other finishes.

## Accessories

No accessories are available.

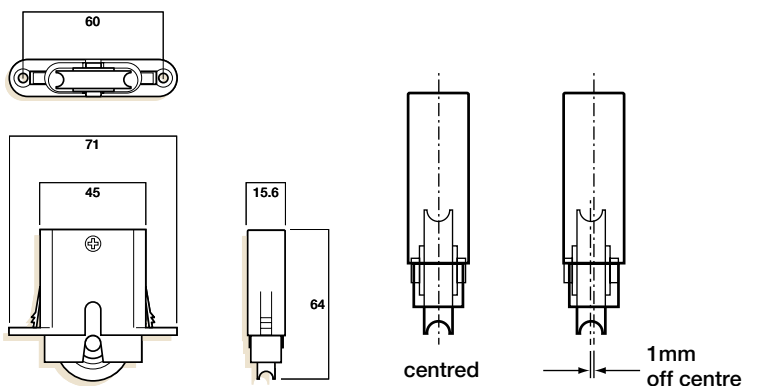

### \*Offset Wheel Function

To offset the door in order to reduce scraping or clashing with another door panel simply remove only the roller from the unit, rotate it 180 degrees, then replace it back into the unit. This will offset the panel or door 1mm.

**Note.** If the offset is incorrectly placed remove the entire unit, rotate it 180 degrees and then replace the entire unit.

## Ordering

### Trade Pack

Spring Loaded W862600



## Whitco<sup>®</sup>

Whitco protects millions of Australian homes and offers the largest range of security and hardware products for residential doors and windows in Australia. With our proud heritage, and by offering a wide variety of locks at affordable prices, Whitco has become one of Australia's most trusted brands.

The Whitco brand is an integral part of ASSA ABLOY Australia Pty Limited, the market leader in the lock and security products industry in Australia.

## ASSA ABLOY

ASSA ABLOY is the global leader in door opening solutions, dedicated to satisfying end-user needs for security, safety and convenience.

ASSA ABLOY is represented in all major regions, in both mature and emerging markets, with leading positions in Australia, Europe and North America.

As the world's leading lock group, ASSA ABLOY offers a more complete product range of door opening solutions than any other company in the market.

**Australia**  
1300 LOCK UP (1300 562 587)  
[whitco.com.au](http://whitco.com.au)

**New Zealand**  
Telephone +64 94157111  
[assaabloy.co.nz](http://assaabloy.co.nz)

**ASSA ABLOY Australia Pty Ltd**  
235 Huntingdale Road  
Oakleigh, Victoria, 3166  
Australia

[info.au@assaabloy.com](mailto:info.au@assaabloy.com)  
[assaabloy.com.au](http://assaabloy.com.au)

**ASSA ABLOY New Zealand Ltd**  
6 Armstrong Road  
Albany, North Shore City, 0632  
New Zealand

[info.nz@assaabloy.com](mailto:info.nz@assaabloy.com)  
[assaabloy.co.nz](http://assaabloy.co.nz)

An ASSA ABLOY Group brand

**Disclaimer**

Whilst every effort has been made to ensure that the information contained in this brochure is accurate at the time of publication, ASSA ABLOY Australia Pty Limited ("ASSA ABLOY") recommends that you consult ASSA ABLOY or its agents prior to placing an order to ascertain current information on specific products, as ASSA ABLOY reserves the right to make any changes without notice. ASSA ABLOY will not be liable for any injury, loss or damage whatsoever, arising from any errors or omissions in the information contained in the brochure or arising from the use or application of the information contained herein.